

# Einwanddosen dickwandig

Thick-walled jars | Pots parois épaisse



## EINWANDDOSEN DICKWANDIG | Thick-walled jars | Pots parois épaisse

### DIMENSIONEN | Dimensions | Dimensions

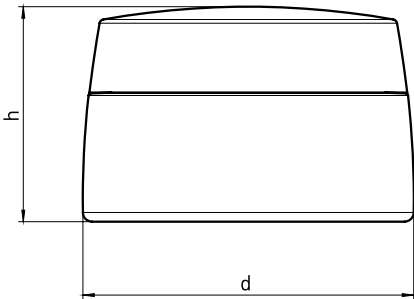

**d = MAX. DURCHMESSER** | Max. diameter | Diamètre max.  
**h = GESAMTHÖHE** | Overall height | Hauteur totale

### DECKELVARIANTEN | Optional lids | Variantes de couvercle

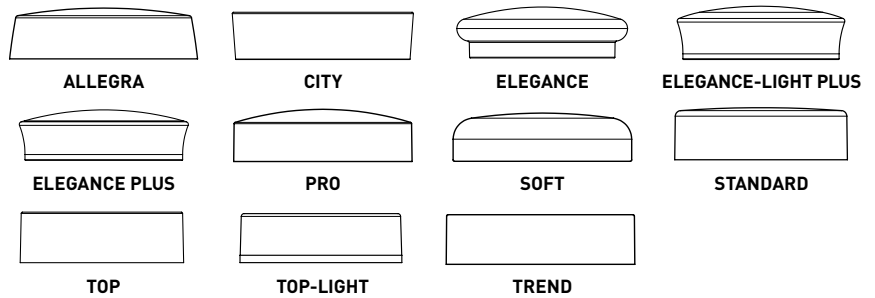

### MATERIAL | Material | Matière

**UNTERTEIL** | Jar | Pot: **SAN**  
**EINSATZ** | Insert | Insert: **PP**  
**SCHRAUBDECKEL** | Lid | Couvercle à vis: **PP, SAN, PP/PP, SAN/PP**

### INDIVIDUELLE DEKORATION

Einfärbung, Druck, Prägung, Lackierung und Metallisierung.

### CUSTOMIZATION

Coloured material, printing, hot foil stamping, lacquering and metallization.

### DÉCORATION PERSONNALISÉE

Sérigraphie, gravure, marquage à chaud, laquage et métallisation.

### TECHNISCHE DATEN | Technical details | Spécifications techniques

NENN VOLUMEN Volume   Volume ml	DOSENUNTERTEIL   Jar   Pot				SCHRAUBDECKEL   Lid   Couvercle à vis							DIMENSIONEN Dimensions Dimensions (mm)	
	NR. No. N°	MATERIAL Material Matière	OBERFLÄCHE Surface Aspect		SERIE Series Série	MATERIAL Material Matière	OBERFLÄCHE Surface Aspect		EINLAGE   Liner   Joint	AUFPLAGE   Disc   Opercule	DICHTLIPPE   Sealing rim   Lèvre d'étanchéité	d	h
			GLATT smooth lisse	MATT matt mat			GLATT smooth lisse	MATT matt mat					
3911	SAN	•			ALLEGRA	SAN/PP	•		•			46	40
					CITY	SAN/PP	•		•			46	39
					ELEGANCE	PP	•	•	•			46	39
					ELEGANCE-LIGHT PLUS	PP		•	•			46	40
					ELEGANCE PLUS	PP		•	•			46	39
					STANDARD	SAN	•		•			46	38
					STANDARD-R	PP/PP	•		•			46	40
					TOP	PP/PP		•	•			46	40
					TOP	SAN/PP	•		•			46	40
					TOP-LIGHT	PP		•	•			46	38
15	MIT EINSATZ   with insert   avec insert				[AUCH REDUZIER-EINSATZ 5 ml VORHANDEN   we also stock reduction inserts in 5 ml   réducteur également disponible en 5 ml]								
	3912	SAN/PP	•		ALLEGRA	SAN/PP	•		•			46	40
					CITY	SAN/PP	•		•			46	39
					ELEGANCE	PP	•	•	•			46	39
					ELEGANCE-LIGHT PLUS	PP		•	•			46	40
					ELEGANCE PLUS	PP		•	•			46	39
					STANDARD	SAN	•		•			46	38
					STANDARD-R	PP/PP	•		•			46	40
					TOP	PP/PP		•	•			46	40
					TOP	SAN/PP	•		•			46	40
TOP-LIGHT					PP		•	•			46	38	

## EINWANDDOSEN DICKWANDIG | Thick-walled jars | Pots parois épaisse

### TECHNISCHE DATEN | Technical details | Spécifications techniques

NENNVOLUMEN Volume   Volume ml	DOSENUNTERTEIL   Jar   Pot				SCHRAUBDECKEL   Lid   Couverture à vis				EINLAGE   Liner   Joint	AUFPLAGE   Disc   Opercule	DICHTLIPPE   Sealing rim   Lèvre d'étanchéité	DIMENSIONEN Dimensions Dimensions (mm)		
	NR. No. N°	MATERIAL Material Matière	OBERFLÄCHE Surface Aspect		SERIE Series Série	MATERIAL Material Matière	OBERFLÄCHE Surface Aspect					d	h	
			GLATT smooth lisse	MATT matt mat			GLATT smooth lisse	MATT matt mat						
3909	SAN	•			ALLEGRA	SAN/PP	•		•			72	48	
					PRO	PP	•		•		72	48		
					SOFT	SAN	•		•		72	48		
					SOFT	PP	•	•	•		72	46		
					STANDARD	PP		•	•		72	44		
					TREND	SAN/PP	•	•	•		72	47		
50	MIT EINSATZ   with insert   avec insert													
	3910	SAN/PP	•			ALLEGRA	SAN/PP	•		•			72	48
						PRO	PP	•		•		72	48	
						SOFT	SAN	•		•		72	48	
						SOFT	PP	•	•	•		72	46	
						STANDARD	PP		•	•		72	44	
TREND						SAN/PP	•	•	•		72	47		

## EINWANDDOSEN DICKWANDIG | Thick-walled jars | Pots parois épaisse

### DIMENSIONEN | Dimensions | Dimensions

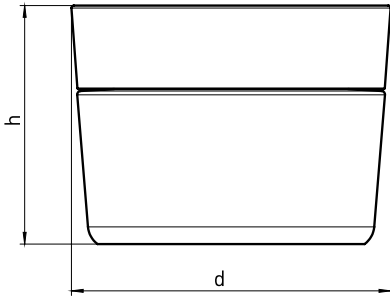

**d = MAX. DURCHMESSER** | Max. diameter | Diamètre max.  
**h = GESAMTHÖHE** | Overall height | Hauteur totale

### DECKELVARIANTEN | Optional lids | Variantes de couvercle

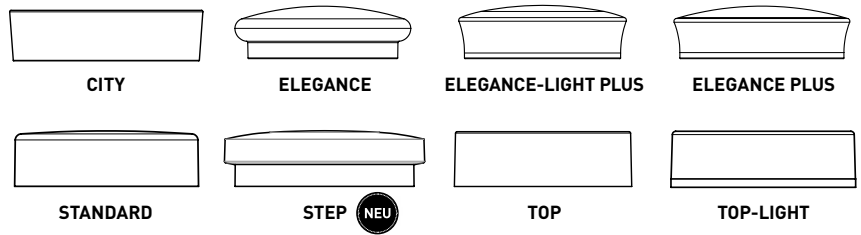

### MATERIAL | Material | Matière

**UNTERTEIL** | Jar | Pot: **SAN**  
**EINSATZ** | Insert | Insert: **PP**  
**SCHRAUBDECKEL** | Lid | Couvercle à vis: **PP, SAN, PP/PP, PS/PP, SAN/PP**

### INDIVIDUELLE DEKORATION

Einfärbung, Druck, Prägung, Lackierung und Metallisierung.

### CUSTOMIZATION

Coloured material, printing, hot foil stamping, lacquering and metallization.

### DÉCORATION PERSONNALISÉE



Sérigraphie, gravure, marquage à chaud, laquage et métallisation.

### TECHNISCHE DATEN | Technical details | Spécifications techniques

NENN VOLUMEN Volume   Volume ml	DOSENUNTERTEIL   Jar   Pot				SCHRAUBDECKEL   Lid   Couvercle à vis				EINLAGE   Liner   Joint	AUFPLAGE   Disc   Opercule	DICHTLIPPE   Sealing rim   Lèvre d'étanchéité	DIMENSIONEN Dimensions Dimensions (mm)	
	NR. No. N°	MATERIAL Material Matière	OBERFLÄCHE Surface Aspect		SERIE Series Série	MATERIAL Material Matière	OBERFLÄCHE Surface Aspect					d	h
			GLATT smooth lisse	MATT matt mat			GLATT smooth lisse	MATT matt mat					
3800	SAN	•			ALLEGRA	SAN/PP	•		•			45	39
					CITY	SAN/PP	•		•			46	38
					ELEGANCE	PP	•	•	•			45	38
					ELEGANCE-LIGHT PLUS	PP		•	•			45	38
					ELEGANCE PLUS	PP		•	•			45	38
					STANDARD	SAN	•		•			45	37
					STANDARD-R	PP/PP	•		•			45	40
					TOP	PP/PP		•	•			45	39
					TOP-LIGHT	PP		•	•			45	37
15	MIT EINSATZ   with insert   avec insert				[AUCH REDUZIER-EINSATZ 5 ml VORHANDEN   we also stock reduction inserts in 5 ml   réducteur également disponible en 5 ml]								
	3801	SAN/PP	•		ALLEGRA	SAN/PP	•		•			45	40
					CITY	SAN/PP	•		•			46	39
					ELEGANCE	PP	•	•	•			45	39
					ELEGANCE-LIGHT PLUS	PP		•	•			45	39
					ELEGANCE PLUS	PP		•	•			45	39
					STANDARD	SAN	•		•			45	38
					STANDARD-R	PP/PP	•		•			45	41
					TOP	PP/PP		•	•			45	40
					TOP-LIGHT	PP		•	•			45	38

**EINWANDDOSEN DICKWANDIG** | Thick-walled jars | Pots parois épaisse

**TECHNISCHE DATEN** | Technical details | Spécifications techniques

NENNVOLUMEN Volume   Volume ml	DOSENUNTERTEIL   Jar   Pot				SCHRAUBDECKEL   Lid   Couvercle à vis				EINLAGE   Liner   Joint	AUFLAGE   Disc   Opercule	DICHTLIPPE   Sealing rim   Lèvre d'étanchéité	DIMENSIONEN Dimensions Dimensions (mm)	
	NR. No. N°	MATERIAL Material Matière	OBERFLÄCHE Surface Aspect		SERIE Series Série	MATERIAL Material Matière	OBERFLÄCHE Surface Aspect					d	h
			GLATT smooth lisse	MATT matt mat			GLATT smooth lisse	MATT matt mat					
3725	SAN	•			CITY	SAN/PP	•		•			69	51
					ELEGANCE	PP	•	•	•			66	52
					ELEGANCE-LIGHT PLUS	PP		•	•			66	54
					ELEGANCE PLUS	PP		•	•			66	53
					STANDARD	SAN	•		•			66	50
					STANDARD	PP	•		•			66	50
					STANDARD-R	PP/PP	•		•			66	54
					STEP 	PS/PP		•	•			66	52
					TOP	PP/PP		•	•			66	53
					TOP	SAN/PP	•		•			66	52
TOP-LIGHT	PP		•	•			66	50					
50	MIT EINSATZ   with insert   avec insert [AUCH REDUZIER-EINSATZ 15 ODER 30 ml VORHANDEN   we also stock reduction inserts in 15 ml and 30 ml   réducteur également disponible en 15 ml ou 30 ml]												
3726	SAN/PP	•			CITY	SAN/PP	•		•			69	51
					ELEGANCE	PP	•	•	•			66	52
					ELEGANCE-LIGHT PLUS	PP		•	•			66	54
					ELEGANCE PLUS	PP		•	•			66	53
					STANDARD	SAN	•		•			66	50
					STANDARD	PP	•		•			66	50
					STANDARD-R	PP/PP	•		•			66	54
					STEP 	PS/PP		•	•			66	52
					TOP	PP/PP		•	•			66	53
					TOP	SAN/PP	•		•			66	52
TOP-LIGHT	PP		•	•			66	50					

## EINWANDDOSEN DICKWANDIG | Thick-walled jars | Pots parois épaisse

### DIMENSIONEN | Dimensions | Dimensions

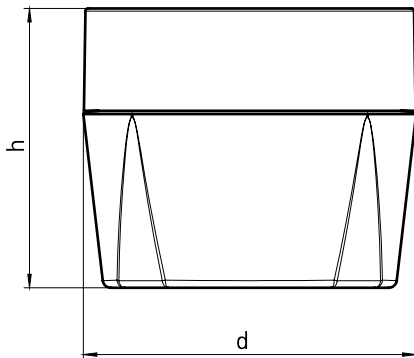

**d = MAX. DURCHMESSER** | Max. diameter | Diamètre max.  
**h = GESAMTHÖHE** | Overall height | Hauteur totale

### DECKELVARIANTEN | Optional lids | Variantes de couvercle

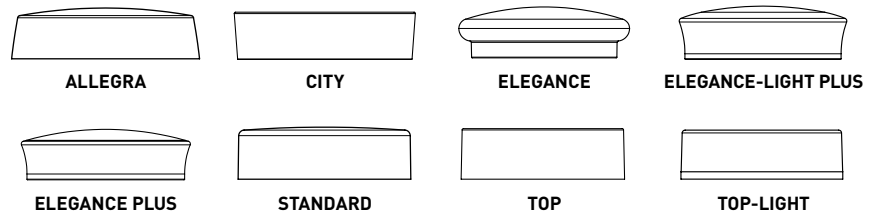

### MATERIAL | Material | Matière

**UNTERTEIL** | Jar | Pot: **SAN**

**EINSATZ** | Insert | Insert: **PP**

**SCHRAUBDECKEL** | Lid | Couvercle à vis: **PP, SAN, PP/PP, SAN/PP**

### INDIVIDUELLE DEKORATION

Einfärbung, Druck, Prägung, Lackierung und Metallisierung.

### CUSTOMIZATION

Coloured material, printing, hot foil stamping, lacquering and metallization.

### DÉCORATION PERSONNALISÉE

Sérigraphie, gravure, marquage à chaud, laquage et métallisation.

### TECHNISCHE DATEN | Technical details | Spécifications techniques

NENN-VOLUMEN Volume   Volume ml	DOSENUNTERTEIL   Jar   Pot				SCHRAUBDECKEL   Lid   Couvercle à vis				EINLAGE   Liner   Joint	AUFPLAGE   Disc   Opercule	DICHTLIPPE   Sealing rim   Lèvre d'étanchéité	DIMENSIONEN Dimensions Dimensions (mm)	
	NR. No. N°	MATERIAL Material Matière	OBERFLÄCHE Surface Aspect		SERIE Series Série	MATERIAL Material Matière	OBERFLÄCHE Surface Aspect					d	h
			GLATT smooth lisse	MATT matt mat			GLATT smooth lisse	MATT matt mat					
3923	SAN	•			ALLEGRA	SAN/PP	•		•		45	41	
					CITY	SAN/PP	•		•		45	39	
					ELEGANCE	PP	•	•	•		45	39	
					ELEGANCE-LIGHT PLUS	PP		•	•		45	39	
					ELEGANCE PLUS	PP		•	•		45	39	
					STANDARD	SAN	•		•		45	38	
					STANDARD-R	PP/PP	•		•		45	41	
					TOP	PP/PP		•	•		45	40	
					TOP	SAN/PP	•		•		45	40	
					TOP-LIGHT	PP		•	•	45	37		
15	MIT EINSATZ   with insert   avec insert				[AUCH REDUZIER-EINSATZ 5 ml VORHANDEN   we also stock reduction inserts in 5 ml   réducteur également disponible en 5 ml]								
	3924	SAN/PP	•		ALLEGRA	SAN/PP	•		•		46	41	
					CITY	SAN/PP	•		•		46	39	
					ELEGANCE	PP	•	•	•		45	39	
					ELEGANCE-LIGHT PLUS	PP		•	•		45	39	
					ELEGANCE PLUS	PP		•	•		45	39	
					STANDARD	SAN	•		•		45	38	
					STANDARD-R	PP/PP	•		•		45	41	
					TOP	PP/PP		•	•		45	40	
					TOP	SAN/PP	•		•		45	40	
									TOP-LIGHT	PP		•	•

## EINWANDDOSEN DICKWANDIG | Thick-walled jars | Pots parois épaisse

### TECHNISCHE DATEN | Technical details | Spécifications techniques

NENNVOLUMEN Volume   Volume ml	DOSENUNTERTEIL   Jar   Pot				SCHRAUBDECKEL   Lid   Couverture à vis				EINLAGE   Liner   Joint	AUFLAGE   Disc   Opercule	DICHTLIPPE   Sealing rim   Lèvre d'étanchéité	DIMENSIONEN Dimensions Dimensions (mm)	
	NR. No. N°	MATERIAL Material Matière	OBERFLÄCHE Surface Aspect		SERIE Series Série	MATERIAL Material Matière	OBERFLÄCHE Surface Aspect					d	h
			GLATT smooth lisse	MATT matt mat			GLATT smooth lisse	MATT matt mat					
3921	SAN	•			ELEGANCE	PP	•	•	•			62	54
					ELEGANCE-LIGHT PLUS	PP		•	•			62	53
					ELEGANCE PLUS	PP		•	•			64	54
					STANDARD	SAN	•		•			62	51
					STANDARD	PP	•		•			62	51
					STANDARD-R	PP/PP	•		•			62	55
					TOP	PP/PP		•	•			62	53
					TOP	SAN/PP	•		•			62	53
					TOP-LIGHT	PP		•	•			62	51
50	MIT EINSATZ   with insert   avec insert				(AUCH REDUZIER-EINSATZ 15 ODER 30 ml VORHANDEN   we also stock reduction inserts in 15 ml and 30 ml   réducteur également disponible en 15 ml ou 30 ml)								
	3922	SAN/PP	•		ELEGANCE	PP	•	•	•			62	54
					ELEGANCE-LIGHT PLUS	PP		•	•			62	53
					ELEGANCE PLUS	PP		•	•			64	54
					STANDARD	SAN	•		•			62	51
					STANDARD	PP	•		•			62	51
					STANDARD-R	PP/PP	•		•			62	55
					TOP	PP/PP		•	•			62	53
					TOP	SAN/PP	•		•			62	53
TOP-LIGHT					PP		•	•			62	51	

## EINWANDDOSEN DICKWANDIG | Thick-walled jars | Pots parois épaisse

### DIMENSIONEN | Dimensions | Dimensions

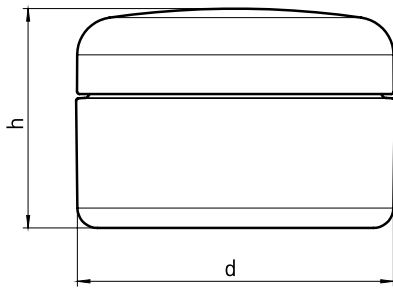

**d = MAX. DURCHMESSER** | Max. diameter | Diamètre max.  
**h = GESAMTHÖHE** | Overall height | Hauteur totale

### DECKELVARIANTEN | Optional lids | Variantes de couvercle

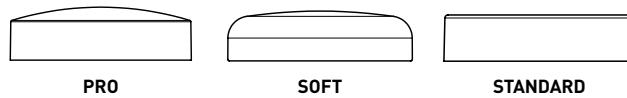

### MATERIAL | Material | Matière

**UNTERTEIL** | Jar | Pot: **SAN**  
**EINSATZ** | Insert | Insert: **PP**  
**SCHRAUBDECKEL** | Lid | Couvercle à vis: **PP, SAN**

### INDIVIDUELLE DEKORATION

Einfärbung, Druck, Prägung, Lackierung und Metallisierung.

### CUSTOMIZATION

Coloured material, printing, hot foil stamping, lacquering and metallization.

### DÉCORATION PERSONNALISÉE

Sérigraphie, gravure, marquage à chaud, laquage et métallisation.

### TECHNISCHE DATEN | Technical details | Spécifications techniques

NENN VOLUMEN Volume   Volume ml	DOSENUNTERTEIL   Jar   Pot				SCHRAUBDECKEL   Lid   Couvercle à vis				EINLAGE   Liner   Joint	AUFLAGE   Disc   Opercule	DICHTLIPPE   Sealing rim   Lèvre d'étanchéité	DIMENSIONEN Dimensions Dimensions (mm)	
	NR. No. N°	MATERIAL Material Matière	OBERFLÄCHE Surface Aspect		SERIE Series Série	MATERIAL Material Matière	OBERFLÄCHE Surface Aspect					d	h
			GLATT smooth lisse	MATT matt mat			GLATT smooth lisse	MATT matt mat					
5	3327	SAN	•		SOFT	SAN	•		•		•	33	26
					STANDARD	SAN	•		•		•	33	25
30	3828	SAN	•		PRO	SAN	•		•			59	37
					PRO	PP	•		•		•	59	36
					SOFT	SAN	•	•	•		•	59	37
					SOFT	PP	•	•	•		•	59	38
					STANDARD	SAN	•		•		•	59	33
					STANDARD	PP	•	•	•		•	59	33
					MIT EINSATZ   with insert   avec insert								
30	3829	SAN/PP	•		PRO	SAN	•		•			59	38
					PRO	PP	•		•		•	59	37
					SOFT	SAN	•	•	•		•	59	38
					SOFT	PP	•	•	•		•	59	39
					STANDARD	SAN	•		•		•	59	34
					STANDARD	PP	•	•	•		•	59	34
50	3830	SAN	•		PRO	PP	•		•			63	46
					SOFT	SAN	•		•		•	63	44
					SOFT	PP	•	•	•		•	63	44
					STANDARD	PP		•	•		•	63	43
50	3831	SAN/PP	•		PRO	PP	•		•			63	47
					SOFT	SAN	•		•		•	63	45
					SOFT	PP	•	•	•		•	63	45
					STANDARD	PP		•	•		•	63	44



## EINWANDDOSEN DICKWANDIG | Thick-walled jars | Pots parois épaisse

### DIMENSIONEN | Dimensions | Dimensions

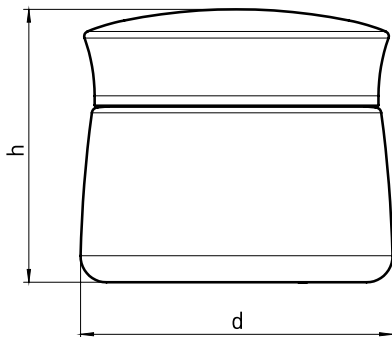

**d = MAX. DURCHMESSER** | Max. diameter | Diamètre max.  
**h = GESAMTHÖHE** | Overall height | Hauteur totale

### DECKELVARIANTEN | Optional lids | Variantes de couvercle

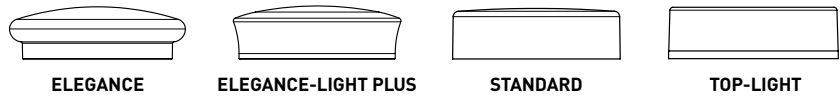

### MATERIAL | Material | Matière

**UNTERTEIL** | Jar | Pot: **SAN**  
**EINSATZ** | Insert | Insert: **PP**  
**SCHRAUBDECKEL** | Lid | Couvercle à vis: **PP, SAN**

### INDIVIDUELLE DEKORATION

Einfärbung, Druck, Prägung, Lackierung und Metallisierung.

### CUSTOMIZATION

Coloured material, printing, hot foil stamping, lacquering and metallization.

### DÉCORATION PERSONNALISÉE

Sérigraphie, gravure, marquage à chaud, laquage et métallisation.

### TECHNISCHE DATEN | Technical details | Spécifications techniques

NENN-VOLUMEN Volume   Volume ml	DOSENUNTERTEIL   Jar   Pot				SCHRAUBDECKEL   Lid   Couvercle à vis							DIMENSIONEN Dimensions Dimensions (mm)	
	NR. No. N°	MATERIAL Material Matière	OBERFLÄCHE Surface Aspect		SERIE Series Série	MATERIAL Material Matière	OBERFLÄCHE Surface Aspect		EINLAGE   Liner   Joint	AUFPLAGE   Disc   Opercule	DICHTLIPPE   Sealing rim   Lèvre d'étanchéité	d	h
			GLATT smooth lisse	MATT matt mat			GLATT smooth lisse	MATT matt mat					
5	3776	SAN	•		ELEGANCE	PP	•	•	•			43	38
					ELEGANCE-LIGHT PLUS	PP		•	•			43	38
					STANDARD	SAN	•		•			43	37
15	MIT EINSATZ   with insert   avec insert				[AUCH REDUZIER-EINSATZ 5 ml VORHANDEN   we also stock reduction inserts in 5 ml   réducteur également disponible en 5 ml]								
	3782	SAN/PP	•		ELEGANCE	PP	•	•	•			43	39
					ELEGANCE-LIGHT PLUS	PP		•	•			43	39
					STANDARD	SAN	•		•			43	38
3775	SAN	•		ELEGANCE	PP	•	•	•			62	53	
				ELEGANCE-LIGHT PLUS	PP		•	•			61	54	
				STANDARD	SAN	•		•			61	51	
				STANDARD	PP	•		•			61	51	
				TOP-LIGHT	PP		•	•			61	52	
50	MIT EINSATZ   with insert   avec insert				[AUCH REDUZIER-EINSATZ 15 ODER 30 ml VORHANDEN   we also stock reduction inserts in 15 ml and 30 ml   réducteur également disponible en 15 ml ou 30 ml]								
	3781	SAN/PP	•		ELEGANCE	PP	•	•	•			62	54
					ELEGANCE-LIGHT PLUS	PP		•	•			61	55
					STANDARD	SAN	•		•			61	52
					STANDARD	PP	•		•			61	52
					TOP-LIGHT	PP		•	•			61	53
3849	SAN	•		STANDARD	PP	•		•			87	78	
				ELEGANCE	PP		•	•			90	83	
200	MIT EINSATZ   with insert   avec insert												
	3850	SAN/PP	•		STANDARD	PP	•		•			87	79
ELEGANCE					PP		•	•			90	84	

## EINWANDDOSEN DICKWANDIG | Thick-walled jars | Pots parois épaisse

### DIMENSIONEN | Dimensions | Dimensions

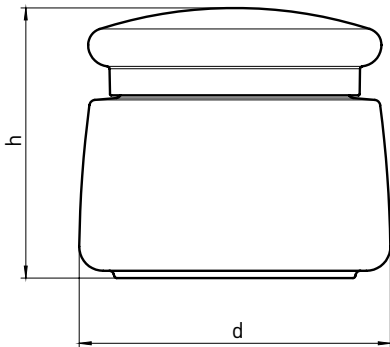

**d = MAX. DURCHMESSER** | Max. diameter | Diamètre max.  
**h = GESAMTHÖHE** | Overall height | Hauteur totale

### DECKELVARIANTEN | Optional lids | Variantes de couvercle

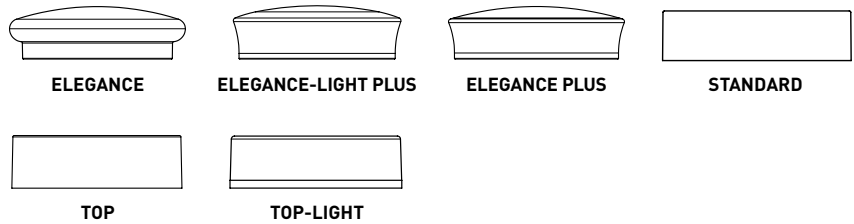

### MATERIAL | Material | Matière

**UNTERTEIL** | Jar | Pot: **SAN**  
**EINSATZ** | Insert | Insert: **PP**  
**SCHRAUBDECKEL** | Lid | Couvercle à vis: **PP, SAN**

### INDIVIDUELLE DEKORATION

Einfärbung, Druck, Prägung, Lackierung und Metallisierung.

### CUSTOMIZATION

Coloured material, printing, hot foil stamping, lacquering and metallization.

### DÉCORATION PERSONNALISÉE

Sérigraphie, gravure, marquage à chaud, laquage et métallisation.

### TECHNISCHE DATEN | Technical details | Spécifications techniques

NENN-VOLUMEN Volume   Volume ml	DOSENUNTERTEIL   Jar   Pot				SCHRAUBDECKEL   Lid   Couvercle à vis									
	NR. No. N°	MATERIAL Material Matière	OBERFLÄCHE Surface Aspect		SERIE Series Série	MATERIAL Material Matière	OBERFLÄCHE Surface Aspect		EINLAGE   Liner   Joint	AUFPLAGE   Disc   Opercule	DICHTLIPPE   Sealing rim   Lèvre d'étanchéité	DIMENSIONEN Dimensions Dimensions (mm)		
			GLATT smooth lisse	MATT matt mat			GLATT smooth lisse	MATT matt mat				d	h	
3600	SAN	•			ELEGANCE	PP	•	•	•			46	40	
					ELEGANCE-LIGHT PLUS	PP		•	•			46	40	
					ELEGANCE PLUS	PP			•	•			46	40
					STANDARD	SAN	•			•			46	38
					TOP-LIGHT	PP			•	•			46	38
15	MIT EINSATZ   with insert   avec insert				[AUCH REDUZIER-EINSATZ 5 ml VORHANDEN   we also stock reduction inserts in 5 ml   réducteur également disponible en 5 ml]									
	3623	SAN/PP	•		ELEGANCE	PP	•	•	•			46	41	
					ELEGANCE-LIGHT PLUS	PP		•	•			46	41	
					ELEGANCE PLUS	PP			•	•			46	41
					STANDARD	SAN	•			•			46	39
					TOP-LIGHT	PP			•	•			46	39
3847					SAN	•		ELEGANCE	PP	•	•	•		
				ELEGANCE PLUS	PP		•	•			56	49		
				STANDARD	SAN	•			•		56	46		
				TOP	SAN/PP	•			•		56	49		
30	MIT EINSATZ   with insert   avec insert				[AUCH REDUZIER-EINSATZ 15 ml VORHANDEN   we also stock reduction inserts in 15 ml   réducteur également disponible en 15 ml]									
	3848	SAN/PP	•		ELEGANCE	PP	•	•	•			56	50	
					ELEGANCE PLUS	PP		•	•			56	50	
					STANDARD	SAN	•			•		56	47	
TOP					SAN/PP	•			•		56	50		

## EINWANDDOSEN DICKWANDIG | Thick-walled jars | Pots parois épaisse

### TECHNISCHE DATEN | Technical details | Spécifications techniques

NENNVOLUMEN Volume   Volume ml	DOSENUNTERTEIL   Jar   Pot				SCHRAUBDECKEL   Lid   Couverture a vis				EINLAGE   Liner   Joint	AUFLAGE   Disc   Opercule	DICHTLIPPE   Sealing rim   Lèvre d'étanchéité	DIMENSIONEN Dimensions Dimensions (mm)	
	NR. No. N°	MATERIAL Material Matière	OBERFLÄCHE Surface Aspect		SERIE Series Série	MATERIAL Material Matière	OBERFLÄCHE Surface Aspect					d	h
			GLATT smooth lisse	MATT matt mat			GLATT smooth lisse	MATT matt mat					
50	3681	SAN	•		ELEGANCE	PP	•	•	•			66	57
					ELEGANCE-LIGHT PLUS	PP		•	•		66	56	
					ELEGANCE PLUS	PP		•	•		66	58	
					STANDARD	SAN	•		•		66	55	
					STANDARD	PP	•		•		66	55	
					TOP-LIGHT	PP		•	•		66	55	
50	MIT EINSATZ   with insert   avec insert (AUCH REDUZIER-EINSATZ 15 ODER 30 ml VORHANDEN   we also stock reduction inserts in 15 ml and 30 ml   réducteur également disponible en 15 ml ou 30 ml)												
	3683	SAN/PP	•		ELEGANCE	PP	•	•	•			66	58
					ELEGANCE-LIGHT PLUS	PP		•	•		66	57	
					ELEGANCE PLUS	PP		•	•		66	59	
					STANDARD	SAN	•		•		66	56	
					STANDARD	PP	•		•		66	56	
TOP-LIGHT					PP		•	•		66	56		
50	3735	SAN	•		STANDARD	PP	•		•		95	78	
					ELEGANCE	PP		•	•		95	82	
200	MIT EINSATZ   with insert   avec insert												
	3736	SAN/PP	•		STANDARD	PP	•		•			95	79
ELEGANCE					PP		•	•		95	83		

**EINWANDDOSEN DICKWANDIG** | Thick-walled jars | Pots parois épaisse

**DIMENSIONEN** | Dimensions | Dimensions

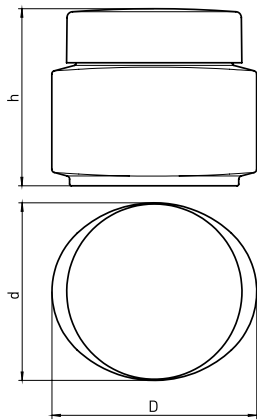

**d = MAX. DURCHMESSER** | Max. diameter | Diamètre max.  
**h = GESAMTHÖHE** | Overall height | Hauteur totale

**DECKELVARIANTEN** | Optional lids | Variantes de couvercle

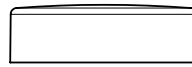

**MATERIAL** | Material | Matière

**UNTERTEIL** | Jar | Pot: **SAN**  
**EINSATZ** | Insert | Insert: **PP**  
**SCHRAUBDECKEL** | Lid | Couvercle à vis: **SAN**

**INDIVIDUELLE DEKORATION**

Einfärbung, Druck, Prägung, Lackierung und Metallisierung.

**CUSTOMIZATION**

Coloured material, printing, hot foil stamping, lacquering and metallization.

**DÉCORATION PERSONNALISÉE**

Sérigraphie, gravure, marquage à chaud, laquage et métallisation.

**TECHNISCHE DATEN** | Technical details | Spécifications techniques

NENNVOLUMEN Volume   Volume ml	DOSENUNTERTEIL   Jar   Pot				SCHRAUBDECKEL   Lid   Couvercle à vis				EINLAGE   Liner   Joint	AUFLAGE   Disc   Opercule	DICHTLIPPE   Sealing rim   Lèvre d'étanchéité	DIMENSIONEN Dimensions Dimensions (mm)	
	NR. No. N°	MATERIAL Material Matière	OBERFLÄCHE Surface Aspect		SERIE Series Série	MATERIAL Material Matière	OBERFLÄCHE Surface Aspect					D/d	h
			GLATT smooth lisse	MATT matt mat			GLATT smooth lisse	MATT matt mat					
15	3384	SAN	•		STANDARD	SAN	•		•			43/37	36
25	MIT EINSATZ   with insert   avec insert												
	3427	SAN/PP	•		STANDARD	SAN	•		•			51/44	45
	3314	SAN	•		STANDARD	SAN	•		•			51/44	45
50	3239	SAN	•		STANDARD	SAN	•		•			60/52	52
	MIT EINSATZ   with insert   avec insert												
	3698	SAN/PP	•		STANDARD	SAN	•		•			60/52	53

## EINWANDDOSEN DICKWANDIG | Thick-walled jars | Pots parois épaisse

### DIMENSIONEN | Dimensions | Dimensions

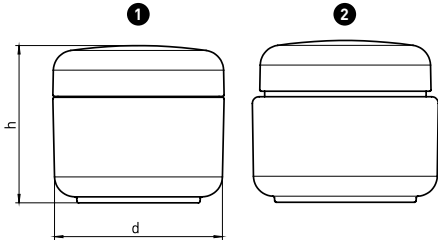

**d = MAX. DURCHMESSER** | Max. diameter | Diamètre max.  
**h = GESAMTHÖHE** | Overall height | Hauteur totale

### DECKELVARIANTEN | Optional lids | Variantes de couvercle

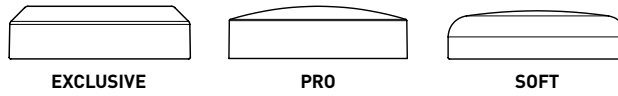

### MATERIAL | Material | Matière

**UNTERTEIL** | Jar | Pot: **SAN**  
**SCHRAUBDECKEL** | Lid | Couvercle à vis: **SAN**  
**AUFLAGE** | Disc | Opercule: **PP**

### INDIVIDUELLE DEKORATION

Einfärbung, Druck, Prägung, Lackierung und Metallisierung.

### CUSTOMIZATION

Coloured material, printing, hot foil stamping, lacquering and metallization.

### DÉCORATION PERSONNALISÉE

Sérigraphie, gravure, marquage à chaud, laquage et métallisation.

### TECHNISCHE DATEN | Technical details | Spécifications techniques

NENN-VOLUMEN Volume   Volume ml	DOSENUNTERTEIL   Jar   Pot				SCHRAUBDECKEL   Lid   Couvercle à vis								
	NR. No. N°	MATERIAL Material Matière	OBERFLÄCHE Surface Aspect		SERIE Series Série	MATERIAL Material Matière	OBERFLÄCHE Surface Aspect		EINLAGE   Liner   Joint	AUFLAGE   Disc   Opercule	DICHTLIPPE   Sealing rim   Lèvre d'étanchéité	DIMENSIONEN Dimensions Dimensions (mm)	
			GLATT smooth lisse	MATT matt mat			GLATT smooth lisse	MATT matt mat				d	h
50	1 3249	SAN	•		EXCLUSIVE	SAN	•		•			51	47
					PRO	SAN	•		•		51	48	
					SOFT	SAN	•		•		51	48	
	2 3304	SAN	•		EXCLUSIVE	SAN	•		•			56	47
					PRO	SAN	•		•		56	48	
					SOFT	SAN	•		•		56	48	
200	1 3282	SAN	•		SOFT	SAN	•		•		78	70	
	1 3472	SAN		•	SOFT	SAN	•		•		78	70	



## EINWANDDOSEN DICKWANDIG | Thick-walled jars | Pots parois épaisse

### DIMENSIONEN | Dimensions | Dimensions

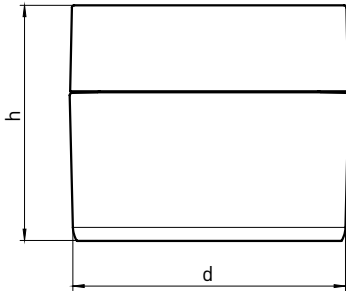

**d = MAX. DURCHMESSER** | Max. diameter | Diamètre max.  
**h = GESAMTHÖHE** | Overall height | Hauteur totale

### DECKELVARIANTEN | Optional lids | Variantes de couvercle

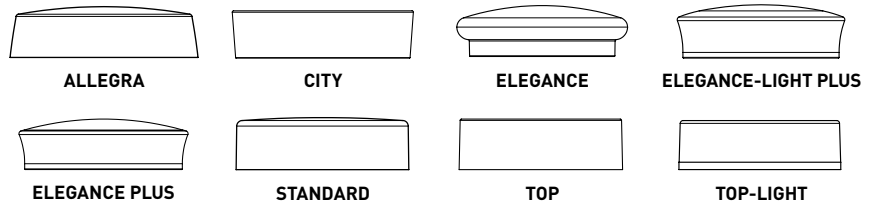

### MATERIAL | Material | Matière

**UNTERTEIL** | Jar | Pot: **SAN**

**EINSATZ** | Insert | Insert: **PP**

**SCHRAUBDECKEL** | Lid | Couvercle à vis: **PP, SAN, PP/PP, SAN/PP**

### INDIVIDUELLE DEKORATION

Einfärbung, Druck, Prägung, Lackierung und Metallisierung.

### CUSTOMIZATION

Coloured material, printing, hot foil stamping, lacquering and metallization.

### DÉCORATION PERSONNALISÉE

Sérigraphie, gravure, marquage à chaud, laquage et métallisation.

### TECHNISCHE DATEN | Technical details | Spécifications techniques

NENNVOLUMEN Volume   Volume ml	DOSENUNTERTEIL   Jar   Pot				SCHRAUBDECKEL   Lid   Couvercle à vis				EINLAGE   Liner   Joint	AUFLAGE   Disc   Opercule	DICHTLIPPE   Sealing rim   Lèvre d'étanchéité	DIMENSIONEN Dimensions Dimensions (mm)	
	NR. No. N°	MATERIAL Material Matière	OBERFLÄCHE Surface Aspect		SERIE Series Série	MATERIAL Material Matière	OBERFLÄCHE Surface Aspect					d	h
			GLATT smooth lisse	MATT matt mat			GLATT smooth lisse	MATT matt mat					
3766	SAN	•			ALLEGRA	SAN/PP	•		•			45	39
					CITY	SAN/PP	•		•			45	39
					ELEGANCE	PP	•	•	•			45	39
					ELEGANCE-LIGHT PLUS	PP		•	•			45	39
					ELEGANCE PLUS	PP		•	•			45	39
					STANDARD	SAN	•		•			45	39
					STANDARD-R	PP/PP	•		•			45	39
					TOP	PP/PP		•	•			45	39
					TOP-LIGHT	PP		•	•			45	39
15	MIT EINSATZ   with insert   avec insert				[AUCH REDUZIER-EINSATZ 5 ml VORHANDEN   we also stock reduction inserts in 5 ml   réducteur également disponible en 5 ml]								
	3767	SAN/PP	•		ALLEGRA	SAN/PP	•		•			45	40
					CITY	SAN/PP	•		•			45	40
					ELEGANCE	PP	•	•	•			45	40
					ELEGANCE-LIGHT PLUS	PP		•	•			45	40
					ELEGANCE PLUS	PP		•	•			45	40
					STANDARD	SAN	•		•			45	40
					STANDARD-R	PP/PP	•		•			45	40
					TOP	PP/PP		•	•			45	40
					TOP-LIGHT	PP		•	•			45	40

**EINWANDDOSEN DICKWANDIG** | Thick-walled jars | Pots parois épaisse

**TECHNISCHE DATEN** | Technical details | Spécifications techniques

NENNVOLUMEN Volume   Volume ml	DOSENUNTERTEIL   Jar   Pot				SCHRAUBDECKEL   Lid   Couverture à vis				EINLAGE   Liner   Joint	AUFLAGE   Disc   Opercule	DICHTLIPPE   Sealing rim   Lèvre d'étanchéité	DIMENSIONEN Dimensions Dimensions (mm)	
	NR. No. N°	MATERIAL Material Matière	OBERFLÄCHE Surface Aspect		SERIE Series Série	MATERIAL Material Matière	OBERFLÄCHE Surface Aspect					d	h
			GLATT smooth lisse	MATT matt mat			GLATT smooth lisse	MATT matt mat					
30	3838	SAN	•		ELEGANCE	PP	•	•	•			53	46
					ELEGANCE PLUS	PP		•	•		55	46	
					STANDARD	SAN	•		•		53	43	
					TOP	SAN/PP	•		•		53	46	
MIT EINSATZ   with insert   avec insert					[AUCH REDUZIER-EINSATZ 15 ml VORHANDEN   we also stock reduction inserts in 15 ml   réducteur également disponible en 15 ml]								
30	3839	SAN/PP	•		ELEGANCE	PP	•	•	•			53	47
					ELEGANCE PLUS	PP		•	•		55	47	
					STANDARD	SAN	•		•		53	44	
					TOP	SAN/PP	•		•		53	47	
50	3729	SAN	•		ELEGANCE	PP	•	•	•			62	52
					ELEGANCE-LIGHT PLUS	PP		•	•		62	53	
					ELEGANCE PLUS	PP		•	•		64	53	
					STANDARD	SAN	•		•		62	50	
					STANDARD	PP	•		•		62	50	
					STANDARD-R	PP/PP	•		•		62	54	
					TOP	PP/PP		•	•		62	53	
					TOP	SAN/PP	•		•		62	53	
					TOP-LIGHT	PP		•	•		62	50	
MIT EINSATZ   with insert   avec insert													
50	3730	SAN/PP	•		ELEGANCE	PP	•	•	•			62	52
					ELEGANCE-LIGHT PLUS	PP		•	•		62	53	
					ELEGANCE PLUS	PP		•	•		64	53	
					STANDARD	SAN	•		•		62	50	
					STANDARD	PP	•		•		62	50	
					STANDARD-R	PP/PP	•		•		62	54	
					TOP	PP/PP		•	•		62	53	
					TOP	SAN/PP	•		•		62	53	
TOP-LIGHT	PP		•	•		62	50						



**EINWANDDOSEN DICKWANDIG** | Thick-walled jars | Pots parois épaisse

**DIMENSIONEN** | Dimensions | Dimensions

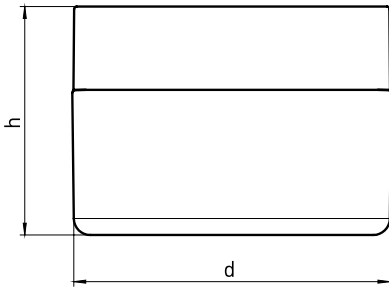

**d = MAX. DURCHMESSER** | Max. diameter | Diamètre max.  
**h = GESAMTHÖHE** | Overall height | Hauteur totale

**DECKELVARIANTEN** | Optional lids | Variantes de couvercle

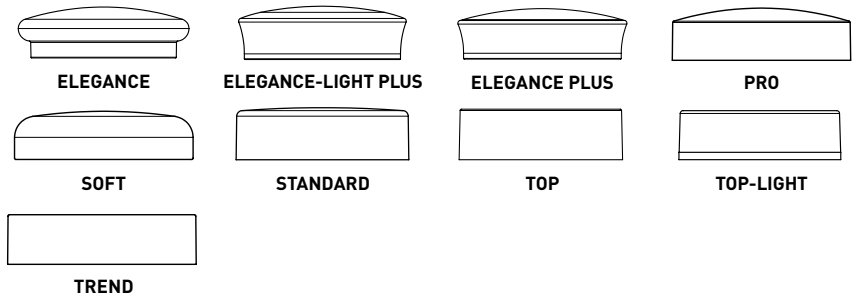

**MATERIAL** | Material | Matière

**UNTERTEIL** | Jar | Pot: **SAN**  
**EINSATZ** | Insert | Insert: **PP**  
**SCHRAUBDECKEL** | Lid | Couvercle à vis: **PP, SAN, SAN/PP**

**INDIVIDUELLE DEKORATION**

Einfärbung, Druck, Prägung, Lackierung und Metallisierung.

**CUSTOMIZATION**

Coloured material, printing, hot foil stamping, lacquering and metallization.

**DÉCORATION PERSONNALISÉE**

Sérigraphie, gravure, marquage à chaud, laquage et métallisation.

**TECHNISCHE DATEN** | Technical details | Spécifications techniques

NENNVOLUMEN Volume   Volume ml	DOSENUNTERTEIL   Jar   Pot				SCHRAUBDECKEL   Lid   Couvercle à vis				EINLAGE   Liner   Joint	AUFPLAGE   Disc   Opercule	DICHTLIPPE   Sealing rim   Lèvre d'étanchéité	DIMENSIONEN Dimensions Dimensions (mm)		
	NR. No. N°	MATERIAL Material Matière	OBERFLÄCHE Surface Aspect		SERIE Series Série	MATERIAL Material Matière	OBERFLÄCHE Surface Aspect					d	h	
			GLATT smooth lisse	MATT matt mat			GLATT smooth lisse	MATT matt mat						
5	3327	SAN	•		SOFT	SAN	•		•		•	33	26	
					STANDARD	SAN	•		•		•	33	25	
30	3927	SAN	•		ELEGANCE	PP	•	•	•			62	40	
					ELEGANCE-LIGHT PLUS	PP		•	•			62	41	
					ELEGANCE PLUS	PP			•	•			64	41
					STANDARD	SAN	•		•				62	38
					STANDARD	PP	•		•				62	38
					STANDARD-R	PP/PP	•		•				62	42
					TOP	PP/PP		•	•				62	41
					TOP	SAN/PP	•		•				62	41
					TOP-LIGHT	PP		•	•				62	38
[AUCH REDUZIER-EINSATZ 15 ml VORHANDEN   we also stock reduction inserts in 15 ml   réducteur également disponible en 15 ml]														
50	3822	SAN	•		PRO	PP	•		•			68	50	
					SOFT	SAN	•		•			68	49	
					SOFT	PP	•	•	•				68	47
					STANDARD	PP		•	•				68	47
					TREND	SAN/PP	•	•	•				68	50
					MIT EINSATZ   with insert   avec insert									
50	3823	SAN/PP	•		PRO	PP	•		•			68	51	
					SOFT	SAN	•		•			68	50	
					SOFT	PP	•	•	•				68	48
					STANDARD	PP		•	•				68	48
					TREND	SAN/PP	•	•	•				68	51

## EINWANDDOSEN DICKWANDIG | Thick-walled jars | Pots parois épaisse

### TECHNISCHE DATEN | Technical details | Spécifications techniques

NENNVOLUMEN Volume   Volume ml	DOSENUNTERTEIL   Jar   Pot				SCHRAUBDECKEL   Lid   Couvercle à vis				EINLAGE   Liner   Joint	AUFLAGE   Disc   Opercule	DICHTLIPPE   Sealing rim   Lèvre d'étanchéité	DIMENSIONEN Dimensions Dimensions (mm)	
	NR. No. N°	MATERIAL Material Matière	OBERFLÄCHE Surface Aspect		SERIE Series Série	MATERIAL Material Matière	OBERFLÄCHE Surface Aspect					d	h
			GLATT smooth lisse	MATT matt mat			GLATT smooth lisse	MATT matt mat					
100	3948	SAN	•		TREND	SAN/PP	•		•			79	57
	MIT EINSATZ   with insert   avec insert												
200	3949	SAN/PP	•		TREND	SAN/PP	•		•			79	57
	3834	SAN	•		TREND	SAN/PP	•		•			95	68
	MIT EINSATZ   with insert   avec insert												
	3835	SAN/PP	•		TREND	SAN/PP	•		•			95	69

NEU

**hopf**

[www.hopf.de](http://www.hopf.de)

## Interesse? Fragen? Wir sind gerne für Sie da!

### **Hopf Packaging GmbH**

Wemdinger Str. 13 | D-86720 Nördlingen  
(Besucher-Anfahrt über Reutheweg)

**Telefon** +49 9081-806-0

**Telefax** +49 9081-806  
-200 Vertrieb  
-203 Versand  
-271 Einkauf

**E-Mail** [info@hopf.de](mailto:info@hopf.de)

**Web** [www.hopf.de](http://www.hopf.de)

QR-Code scannen &  
Website besuchen!

